

【背面図 S=1:15】

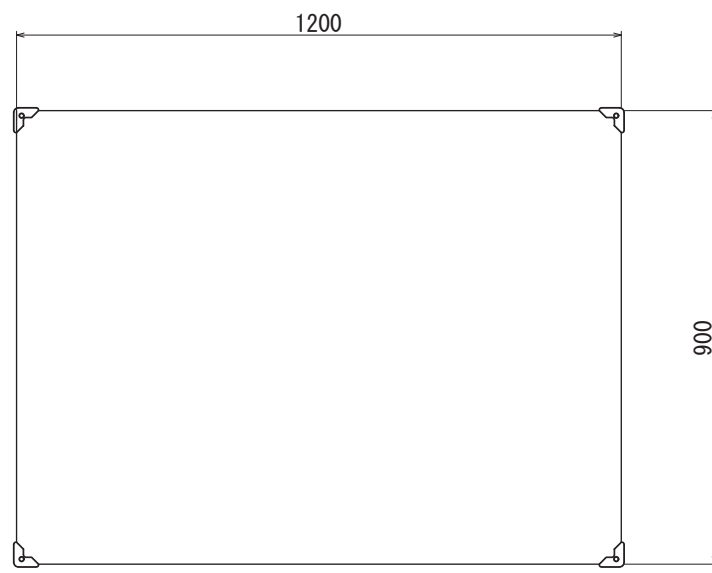

【正面図 S=1:15】



【側面図 S=1:15】

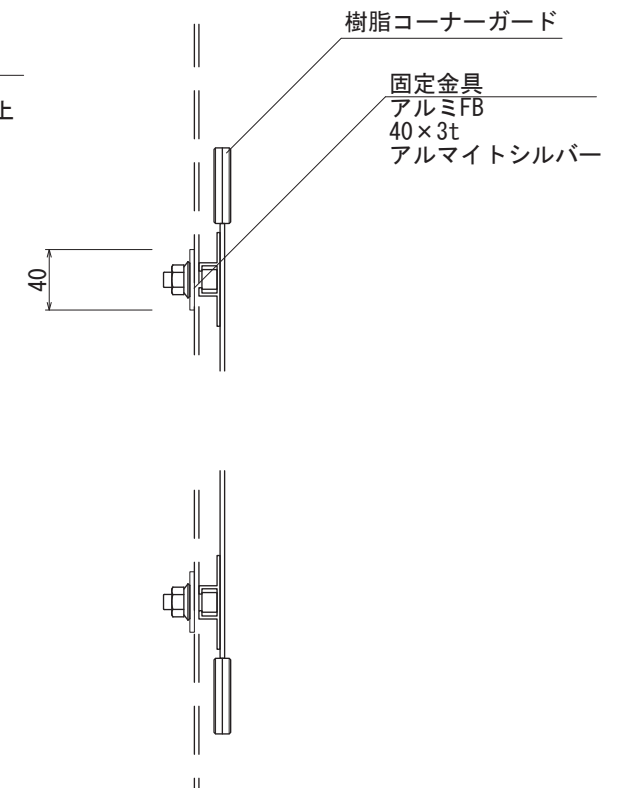
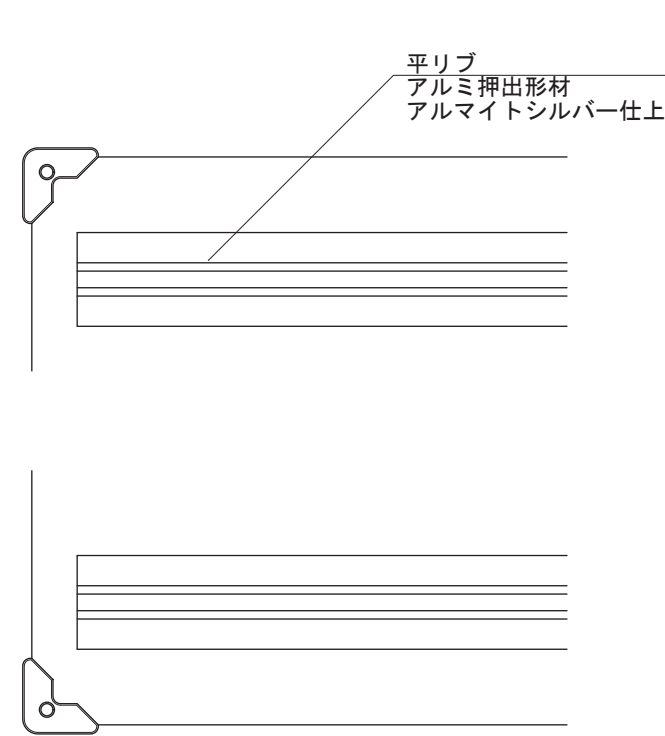
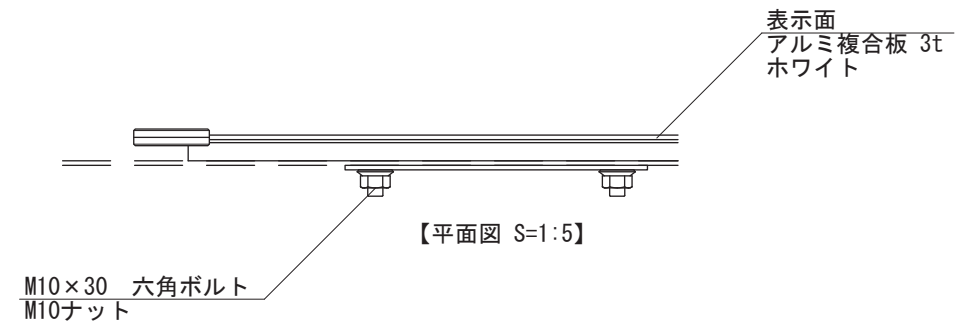
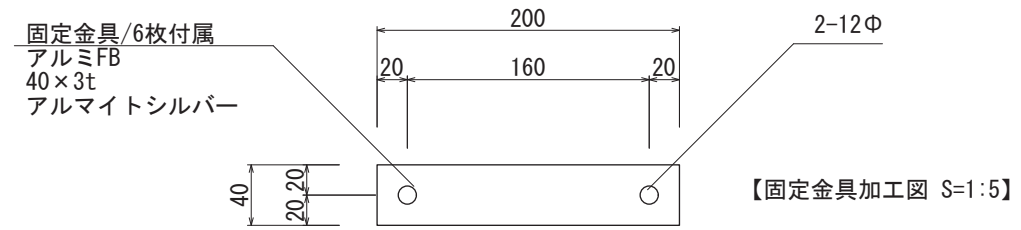

図面番号 No.	図面名称	設計年月日	承認	設計	担当		
	COF-7						